

## Transient Voltage Suppressors (TVS) Data Sheet

### Features

- For surface mounted applications in order to optimize board space
- Low profile package
- Built-in strain relief
- Glass passivated junction
- Low inductance
- Excellent clamping capability
- 600W peak pulse power capability at 10/1000 $\mu$ s waveform, repetition rate (duty cycle): 0.01%
- Fast response time
- Typical  $I_R$  less than 1 $\mu$ A above 10V
- High Temperature soldering: 260 $^{\circ}$ C/10 seconds at terminals
- Plastic package has underwriters laboratory flammability 94V-0
- Meets MSL level 1, per J-STD-020
- Safety certification: UL: E244458
- AEC-Q101 qualified

### Mechanical Data

- Case: JEDEC DO-214AA. Molded plastic over glass passivated junction
- Terminal: Solder plated, solderable per MIL-STD-750, Method 2026
- Polarity: Color band denotes cathode except bi-directional models
- Standard Packaging: 12mm tape (EIA STD RS-481)
- Weight: 0.10g

### Applications

- I/O interface
- AC/DC power supply
- Low frequency signal transmission line (RS232, RS485, etc.)

### Maximum Ratings and Characteristics

Ratings at 25 $^{\circ}$ C ambient temperature unless otherwise specified.

Rating	Symbol	Value	Units
Peak pulse power dissipation at 10/1000 $\mu$ s waveform (Note1, Note2, Fig.1)	$P_{PPM}$	Minimum 600	Watts
Peak pulse current of at 10/1000 $\mu$ s waveform (Note 1, Fig.3)	$I_{PPM}$	See Table	Amps
Steady state power dissipation at $T_A=50^{\circ}$ C (Fig.5)	$P_{M(AV)}$	5.0	Watts
Peak forward surge current, 8.3ms single half sine-wave superimposed on rated load, (JEDEC Method) (Note3, Fig.6)	$I_{FSM}$	100	Amps
Operating junction and Storage Temperature Range.	$T_J, T_{STG}$	-65 to +150	$^{\circ}$ C
Typical thermal resistance junction to lead	$R_{\theta JL}$	20	$^{\circ}$ C/W
Typical thermal resistance junction to ambient	$R_{\theta JA}$	100	$^{\circ}$ C/W

Notes: 1. Non-repetitive current pulse, per Fig.3 and derated above  $T_A=25^{\circ}$ C per Fig.2.

2. Mounted on 5.0mm $\times$ 5.0mm (0.03mm thick) copper pads to each terminal.

3. 8.3ms single half sine-wave, or equivalent square wave, duty cycle=4 pulses per minutes maximum.

**Dimensions (SMB/DO-214AA)**

	Symbol	Millimeters		Inches	
		Min.	Max.	Min.	Max.
	L	4.06	4.57	0.160	0.180
	D	3.30	3.94	0.130	0.155
	D1	1.95	2.20	0.077	0.086
	T	5.21	5.59	0.205	0.220
	T1	0.76	1.52	0.030	0.060
	d	-	0.203	-	0.008
	H	2.15	2.65	0.085	0.104
	H1	2.13	2.47	0.084	0.097

**Electrical Characteristics (T<sub>A</sub>=25°C)**

Part Number		Device Marking Code		Reverse Stand-Off Voltage	Breakdown Voltage @I <sub>T</sub>	Test Current	Maximum Clamping Voltage @I <sub>PP</sub>	Peak Pulse Current	Reverse Leakage @V <sub>RWM</sub>
Unidirectional	Bidirectional	UNI	BI	V <sub>RWM</sub> (V)	V <sub>BR</sub> (V)	I <sub>T</sub> (mA)	V <sub>C</sub> (V)	I <sub>PP</sub> (A)	I <sub>R</sub> (μA)
SMBJ11A-AT	SMBJ11CA-AT	KZ	AZ	11.0	12.20~13.50	1	18.2	33.0	1
SMBJ12A-AT	SMBJ12CA-AT	LE	BE	12.0	13.30~14.70	1	19.9	30.2	1
SMBJ13A-AT	SMBJ13CA-AT	LG	BG	13.0	14.40~15.90	1	21.5	28.0	1
SMBJ14A-AT	SMBJ14CA-AT	LK	BK	14.0	15.60~17.20	1	23.2	25.9	1
SMBJ15A-AT	SMBJ15CA-AT	LM	BM	15.0	16.70~18.50	1	24.4	24.6	1
SMBJ16A-AT	SMBJ16CA-AT	LP	BP	16.0	17.80~19.70	1	26.0	23.1	1
SMBJ17A-AT	SMBJ17CA-AT	LR	BR	17.0	18.90~20.90	1	27.6	21.8	1
SMBJ18A-AT	SMBJ18CA-AT	LT	BT	18.0	20.00~22.10	1	29.2	20.6	1
SMBJ20A-AT	SMBJ20CA-AT	LV	BV	20.0	22.20~24.50	1	32.4	18.6	1
SMBJ22A-AT	SMBJ22CA-AT	LX	BX	22.0	24.40~26.90	1	35.5	16.9	1
SMBJ24A-AT	SMBJ24CA-AT	LZ	BZ	24.0	26.70~29.50	1	38.9	15.5	1
SMBJ26A-AT	SMBJ26CA-AT	ME	CE	26.0	28.90~31.90	1	42.1	14.3	1
SMBJ28A-AT	SMBJ28CA-AT	MG	CG	28.0	31.10~34.40	1	45.4	13.3	1
SMBJ30A-AT	SMBJ30CA-AT	MK	CK	30.0	33.30~36.80	1	48.4	12.4	1
SMBJ33A-AT	SMBJ33CA-AT	MM	CM	33.0	36.70~40.60	1	53.3	11.3	1
SMBJ36A-AT	SMBJ36CA-AT	MP	CP	36.0	40.00~44.20	1	58.1	10.4	1
SMBJ40A-AT	SMBJ40CA-AT	MR	CR	40.0	44.40~49.10	1	64.5	9.3	1

**Electrical Characteristics (T<sub>A</sub>=25°C)**

Part Number		Device Marking Code		Reverse Stand-Off Voltage	Breakdown Voltage @I <sub>T</sub>	Test Current	Maximum Clamping Voltage @I <sub>PP</sub>	Peak Pulse Current	Reverse Leakage @V <sub>RWM</sub>
Unidirectional	Bidirectional	UNI	BI	V <sub>RWM</sub> (V)	V <sub>BR</sub> (V)	I <sub>T</sub> (mA)	V <sub>C</sub> (V)	I <sub>PP</sub> (A)	I <sub>R</sub> (μA)
SMBJ43A-AT	SMBJ43CA-AT	MT	CT	43.0	47.80~52.80	1	69.4	8.7	1
SMBJ45A-AT	SMBJ45CA-AT	MV	CV	45.0	50.00~55.30	1	72.7	8.3	1
SMBJ48A-AT	SMBJ48CA-AT	MX	CX	48.0	53.30~58.90	1	77.4	7.8	1
SMBJ51A-AT	SMBJ51CA-AT	MZ	CZ	51.0	56.70~62.70	1	82.4	7.3	1
SMBJ54A-AT	SMBJ54CA-AT	NE	DE	54.0	60.00~66.30	1	87.1	6.9	1
SMBJ58A-AT	SMBJ58CA-AT	NG	DG	58.0	64.40~71.20	1	93.6	6.5	1
SMBJ60A-AT	SMBJ60CA-AT	NK	DK	60.0	66.70~73.70	1	96.8	6.2	1
SMBJ64A-AT	SMBJ64CA-AT	NM	DM	64.0	71.10~78.60	1	103.0	5.9	1
SMBJ70A-AT	SMBJ70CA-AT	NP	DP	70.0	77.80~86.00	1	113.0	5.3	1
SMBJ75A-AT	SMBJ75CA-AT	NR	DR	75.0	83.30~92.10	1	121.0	5.0	1
SMBJ78A-AT	SMBJ78CA-AT	NT	DT	78.0	86.70~95.80	1	126.0	4.8	1
SMBJ85A-AT	SMBJ85CA-AT	NV	DV	85.0	94.40~104.00	1	137.0	4.4	1
SMBJ90A-AT	SMBJ90CA-AT	NX	DX	90.0	100.00~111.00	1	146.0	4.1	1
SMBJ100A-AT	SMBJ100CA-AT	NZ	DZ	100.0	111.00~123.00	1	162.0	3.7	1
SMBJ110A-AT	SMBJ110CA-AT	PE	EE	110.0	122.00~135.00	1	177.0	3.4	1
SMBJ120A-AT	SMBJ120CA-AT	PG	EG	120.0	133.00~147.00	1	193.0	3.1	1
SMBJ130A-AT	SMBJ130CA-AT	PK	EK	130.0	144.00~159.00	1	209.0	2.9	1
SMBJ150A-AT	SMBJ150CA-AT	PM	EM	150.0	167.00~185.00	1	243.0	2.5	1
SMBJ160A-AT	SMBJ160CA-AT	PP	EP	160.0	178.00~197.00	1	259.0	2.3	1
SMBJ170A-AT	SMBJ170CA-AT	PR	ER	170.0	189.00~209.00	1	275.0	2.2	1
SMBJ180A-AT	SMBJ180CA-AT	PT	ET	180.0	201.00~222.00	1	292.0	2.1	1
SMBJ190A-AT	SMBJ190CA-AT	PA	EC	190.0	211.00~233.00	1	308.0	2.0	1
SMBJ200A-AT	SMBJ200CA-AT	PV	EV	200.0	224.00~247.00	1	324.0	1.9	1
SMBJ210A-AT	SMBJ210CA-AT	PB	ED	210.0	237.00~263.00	1	340.0	1.8	1
SMBJ220A-AT	SMBJ220CA-AT	PX	EX	220.0	246.00~272.00	1	356.0	1.7	1
SMBJ250A-AT	SMBJ250CA-AT	PZ	EZ	250.0	279.00~309.00	1	405.0	1.5	1
SMBJ300A-AT	SMBJ300CA-AT	QE	FE	300.0	335.00~371.00	1	486.0	1.3	1
SMBJ350A-AT	SMBJ350CA-AT	QG	FG	350.0	391.00~432.00	1	567.0	1.1	1
SMBJ400A-AT	SMBJ400CA-AT	QK	FK	400.0	447.00~494.00	1	648.0	0.9	1
SMBJ440A-AT	SMBJ440CA-AT	QM	FM	440.0	492.00~543.00	1	713.0	0.9	1

**Ratings and Characteristic Curves ( $T_A=25^\circ\text{C}$  unless otherwise noted)**

Figure 1. Peak Pulse Power Rating Curve

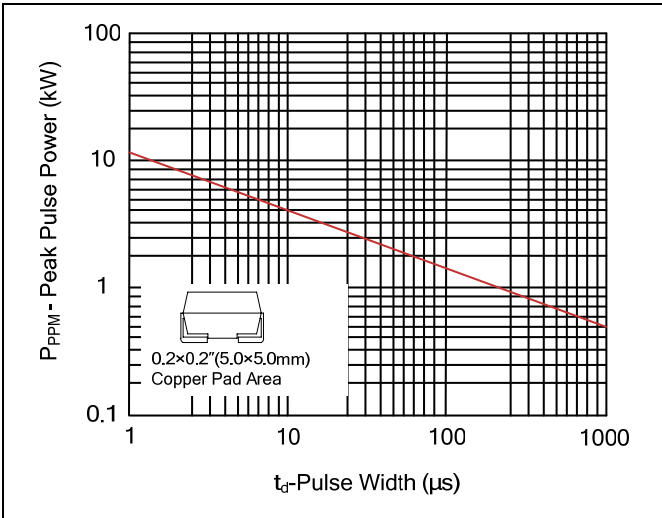

Figure 2. Pulse Derating Curve

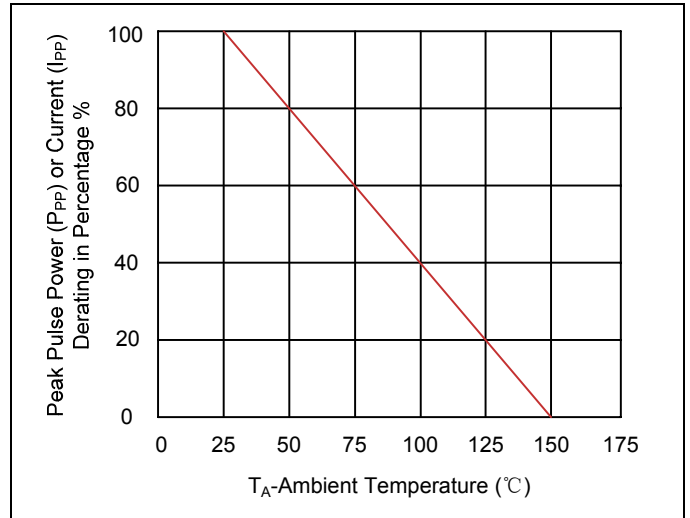

Figure 3. Pulse Waveform

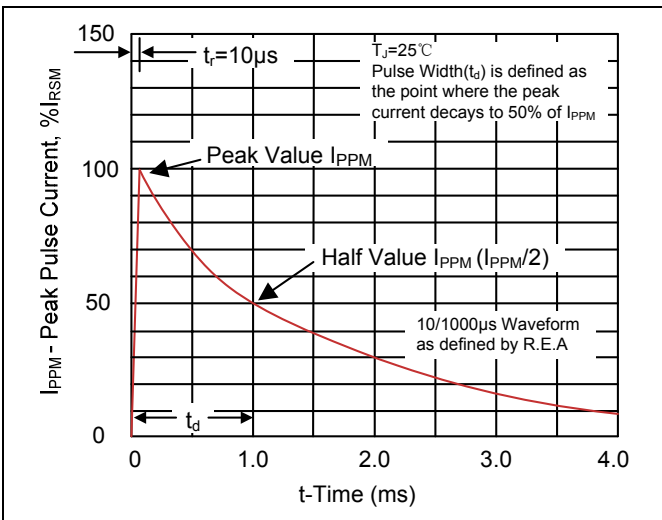

Figure 4. Typical Junction Capacitance

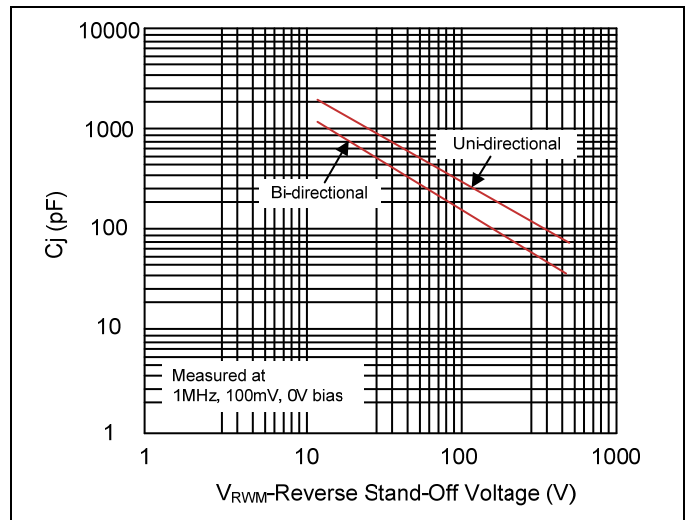

Figure 5. Steady State Power Dissipation Derating Curve

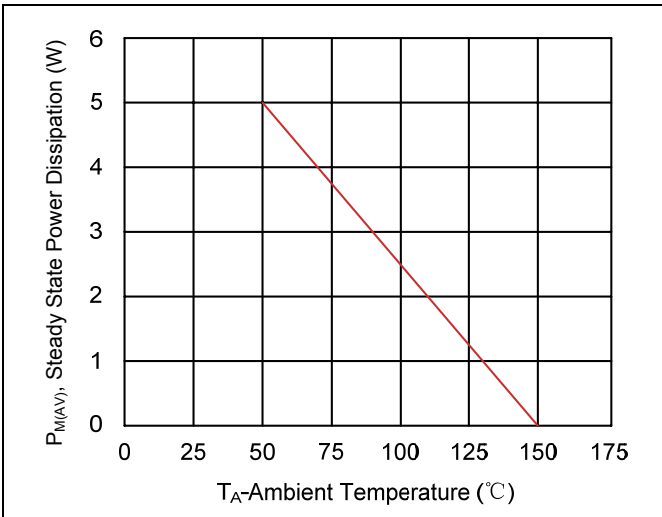
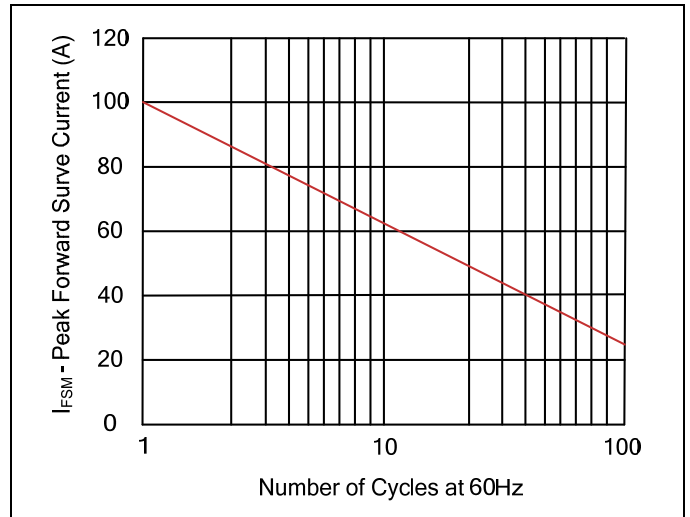

Figure 6. Maximum Non-Repetitive Forward Surge Current Uni-Directional Only



**Recommended Soldering Conditions**



**Recommended Conditions**

Profile Feature	Pb-Free Assembly
Average ramp-up rate ( $T_L$ to $T_P$ )	3°C/second max.
Preheat -Temperature Min ( $T_{S\ min}$ ) -Temperature Max ( $T_{S\ max}$ ) -Time (min to max) ( $t_s$ )	150°C 200°C 60-180 seconds
$T_{S\ max}$ to $T_L$ -Ramp-up Rate	3°C/second max.
Time maintained above: -Temperature ( $T_L$ ) -Time ( $t_L$ )	217°C 60-150 seconds
Peak Temperature ( $T_P$ )	260°C
Time within 5°C of actual Peak Temperature ( $t_p$ )	20-40 seconds
Ramp-down Rate	6°C/second max.
Time 25°C to Peak Temperature	8 minutes max.

**Marking Code**

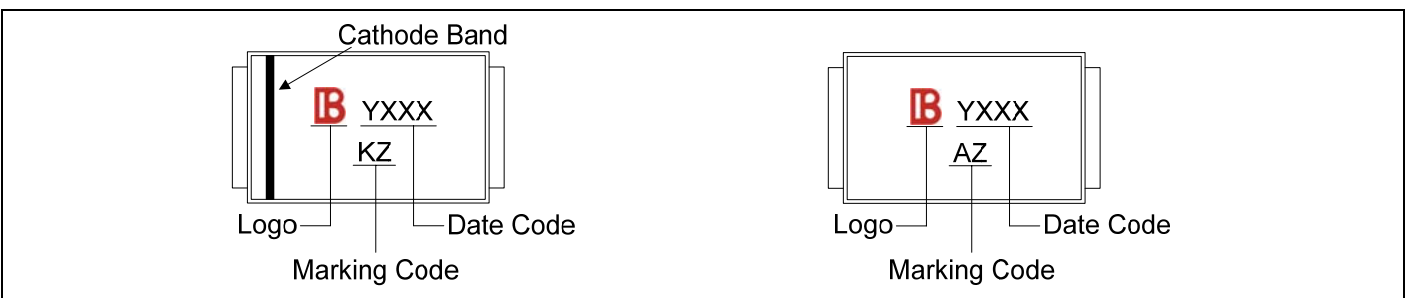

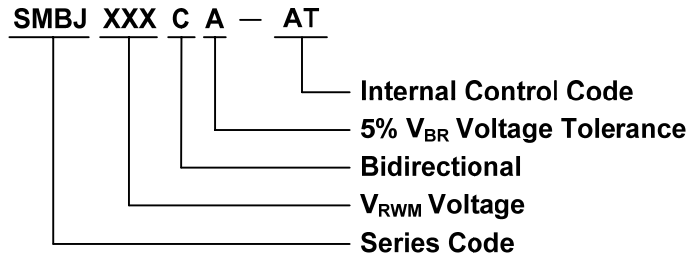

**Packaging**

Tape	Symbol	Dimension (mm)
	W	12.00±0.20
	P0	4.00±0.10
	P1	8.00±0.10
	P2	2.00±0.10
	D0	Φ1.55±0.10
	D1	Φ1.5±0.10
	E	1.75±0.10
	F	5.50±0.10
	A0	3.86±0.15
	B0	5.65±0.10
	K0	2.75±0.15
	T	0.25±0.05
	<p>7" Reel</p>	D2
D3		Φ50.0Min.
D4		Φ13.0±0.5
W1		16.0±2.0
Quantity: 500PCS		
<p>13" Reel</p>	D5	Φ330.0±2.0
	D6	Φ13.5±0.5
	H	2.5±1.0
	W2	16.0±2.0
	Quantity: 3000PCS	